

Inverter Smart Manual

Table of Contents

1. Safety instructions	1
2. General description	2
2.1. Inverter	2
2.2. LED diagnosis and monitoring	2
2.3. The VictronConnect app	2
2.4. Bluetooth	3
2.5. VE.Direct port	3
2.6. Remote on/off control	3
2.7. Programmable relay	3
3. Installation	4
3.1. Physical installation	4
3.1.1. Location	4
3.1.2. Mounting	4
3.2. Electrical installation	4
3.2.1. Battery connection	5
3.2.2. Solar connection	5
3.2.3. Chassis to ground connection	5
3.2.4. Remote connector	6
3.2.5. VE.Direct connection	6
3.2.6. Programmable relay	6
4. Configuration	7
4.1. AC output voltage and frequency	7
4.2. ECO mode and ECO settings	7
4.3. Low battery alarm and charge detect settings	7
4.3.1. Dynamic cut off	8
4.4. Programmable relay	9
4.5. Firmware update	9
4.6. Reset settings to default	10
5. Operation	11
5.1. Inverter	11
5.1.1. On/Off Push button	11
5.1.2. On/off Switch (5kVA only)	11
5.1.3. ECO Mode	11
5.2. LED definitions and troubleshooting	11
5.3. Protections and automatic restarts	14
5.4. Monitoring via VictronConnect	14
5.5. Monitoring via a GX device, GlobalLink and the VRM portal	15
6. Technical specifications	16
6.1. Inverter Smart	16
7. Appendix	18
7.1. Connection overview	18
7.2. Installation information floating ground 1600VA and 2000VA models	20
7.3. Installation information floating ground 3000VA and 5000VA models	21
7.4. Dimensions 1600VA and 2000VA model	22
7.5. Dimensions 3000VA model (12V)	23
7.6. Dimensions 3000VA model (24V, 48V)	24
7.7. Dimensions 5000VA model	25

1. Safety instructions

General

Please read the documentation supplied with this product first, so that you are familiar with the safety signs and directions before using the product. This product is designed and tested in accordance with international standards. The equipment should be used for the designated application only.



- **WARNING - These servicing instructions are for use by qualified personnel only. To reduce the risk of electric shock, do not perform any servicing other than that specified in the operating instructions unless you are qualified to do so.**
- **WARNING - ELECTRIC SHOCK HAZARD** - The product is used in conjunction with a permanent energy source (battery). Input and/or output terminals may still be dangerously energized, even when the equipment is switched off. Always disconnect the battery before carrying out maintenance or servicing the product.



- The product has no internal user-serviceable components. Do not remove the front plate or operate the product if any panels have been removed. All servicing must be undertaken by qualified personnel.
- Please read the installation instructions in the installation manual before installing the equipment.
- This is a Safety Class I product (supplied with a protective grounding terminal). The chassis must be grounded. A grounding point is located on the outside of the product. Whenever it is likely that the grounding protection has been damaged, the product must be turned off and secured against unintended operation; please contact qualified service staff.
- Ensure that the equipment is used under the correct ambient conditions.
Never operate the product in a wet or dusty environment.
Never use the product where there is a risk of gas or dust explosions.
- Ensure that there is adequate free space (10 cm) for ventilation around the product and check that the ventilation vents are not blocked.
- This appliance is not intended for use by persons (including children) with reduced physical, sensory or mental capabilities, or lack of experience and knowledge unless they have been given supervision or instruction concerning the use of the appliance by a person responsible for their safety.
- Children should be supervised to ensure that they do not play with the appliance.
- Use of an attachment not recommended or sold by the marine unit manufacturer may result in a risk of fire, electric shock, or injury to persons.

Transport and storage

Ensure that the mains power and battery leads have been disconnected before storing or transporting the product.

No liability can be accepted for any transport damage if the equipment is shipped in non-original packaging.

Store the product in a dry environment; the storage temperature must be between -20°C and 60°C.

Consult the battery manufacturer's manual in respect of transport, storage, charging, recharging and disposal of the battery.

2. General description

2.1. Inverter

Proven reliability

The inverter uses a full bridge with toroidal transformer topology that has proven its reliability over many years. It is short circuit proof and protected against overheating, whether due to overload or high ambient temperature.

High startup power

To start loads such as: equipment with an electric motor, power converters for LED lamps, filament lamps or electric tools.

ECO mode

ECO mode reduces the inverter power consumption by approximately 85% by going into standby operation when there are no loads connected to the inverter. When the inverter has been switched to ECO mode, it will enter standby operation when the load is less than a preset value. While in standby operation, the inverter will check every few seconds if the load has increased again. If the load has increased, the inverter will leave standby operation and resumes regular inverter operation. The sensitivity of the ECO mode is configurable.

Fully configurable

- AC output voltage and frequency.
- Low battery voltage cut-off and restart levels.
- ECO mode on/off and ECO mode sensitivity level.
- Programmable relay.

To transfer the load to another AC source: The automatic transfer switch

For inverters we recommend our [Filax2](#) automatic transfer switch. The Filax2 features a very short switchover time (less than 20 milliseconds) so that computers and other electronic equipment will continue to operate without disruption. Alternatively use an [inverter/charger](#) with built-in transfer switch.

2.2. LED diagnosis and monitoring

The inverter indicates basic operational information and alarms via its LEDs:

- Inverter state.
- Overload warning or alarm.
- Over temperature warning or alarm.
- Low battery voltage warning or alarm.
- High DC ripple warning or alarm.

Additional parameters can be monitored via VictronConnect:

- Inverter state.
- Battery voltage.
- AC output voltage.
- AC load.
- Relay state.
- Warning and alarms.

For the full list of all LED indications and monitoring parameters see the [Operation \[11\]](#) chapter.

2.3. The VictronConnect app

The VictronConnect app is used to monitor, control and configure the inverter. The app can be installed on a phone, tablet or computer. The app is available for Android, iOS, Windows and macOS. The app either communicates via Bluetooth or via USB interfaced to the VE.Direct port.

For more information about the app and to download the app see the [VictronConnect product page](#).

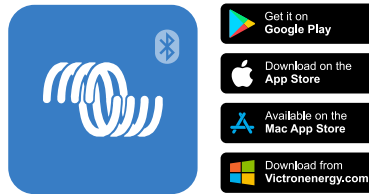

2.4. Bluetooth

The inverter has built-in Bluetooth.

Bluetooth (but also a VE.Direct connection) can be used to communicate with the VictronConnect app.

2.5. VE.Direct port

The inverter is equipped with a VE.Direct port. This port can be used to connect the inverter to:

- The [VictronConnect app](#) via a [VE.Direct to USB interface](#).
- The [VictronConnect app](#) via a [VE.Direct Bluetooth Smart dongle](#).
- A GX monitoring device, such as the [Cerbo GX](#). Note that an additional [VE.Direct cable](#) is needed for this.
- The [GlobalLink 520](#). Note that an additional [VE.Direct cable](#) is needed for this.

2.6. Remote on/off control

The inverter can be remotely turned on or off in the following ways:

- Via the VictronConnect app.
- With an (optional) external switch connected to the remote connector.
- With the (optional) [Inverter Control VE.Direct](#) panel connected to the remote connector.
- From a BMS (Battery Management System) connected to the remote connector.
- Via a GX device and/or the VRM portal (optional).

For more information see the [Remote connector \[6\]](#) chapter.

2.7. Programmable relay

The inverter is equipped with a programmable relay. This relay can be used, for example, to interact with an external monitoring or alarm system or drive an extraction fan.

For more information see the [Programmable relay \[6\]](#) chapter.

3. Installation



- This product should be installed by a qualified electrician.
- During installation ensure that the remote connector with wire bridge is removed (or switch off the remote on/off switch if installed) to be sure that the inverter cannot be switched on unexpectedly.

3.1. Physical installation

For a dimension drawing of the inverter, see the [Appendix \[18\]](#) of this manual.

3.1.1. Location

To ensure a trouble free operation of the inverter, it must be used in locations that meet the following requirements:

- Avoid any contact with water. Do not expose the inverter to rain or moisture.
- Install the inverter in a dry and well-ventilated area.
- For best operating results, the inverter should be mounted on a flat surface.
- Mount as close as possible to the batteries. Try and keep the distance between the product and the battery to a minimum in order to minimize cable voltage losses.
- There should be a clear space of at least 10cm around the appliance for cooling. Do not obstruct the airflow around the inverter. When the inverter is running too hot, it will shut down. When the inverter has reached a safe temperature level, the unit will automatically restart again.
- Do not place the unit in direct sunlight. The ambient air temperature should be between -20°C and 40°C (humidity <95% non-condensing). Note that in extreme situations the inverter's case temperature can exceed 70°C.



- Excessive high ambient temperature will result in a reduced service life, reduced peak power rating or shutdown of the inverter.
- Never mount the inverter directly above the batteries.
- For safety purposes, this product should be installed in a heat resistant environment if it is used with equipment where a substantial amount of power is to be converted. You should prevent the presence of e.g. chemicals, synthetic components, curtains or other textiles, etc., in the immediate vicinity.

3.1.2. Mounting

The inverter is designed to be vertically wall mounted. However, it can also be mounted horizontally or lying down, but these positions will not offer optimum cooling.

The inverter ships with a wall mounting bracket and 5 screws.

Mount the inverter as follows:

1. Mount the mounting bracket on a wall, using 3 screws.
2. Remove the bottom cover from the inverter.
3. Hang the inverter on the wall mounting bracket.
4. Ensure that the inverter has slotted correctly into the wall bracket.
5. Secure the inverter on the wall using the mounting holes in the bottom right and bottom left of the inverter, using the remaining 2 screws.



The interior of the product must remain accessible after installation.

3.2. Electrical installation

For a connection overview drawing of the inverter, see appendix [Connection overview \[18\]](#).

3.2.1. Battery connection

In order to fully utilize the full capacity of the inverter, it is important to use batteries with sufficient capacity and battery cables with sufficient cross section.

There is no safety fuse inside the inverter. A safety fuse should be installed externally.

See below table for the recommended battery cable cross section, safety fuse rating and battery capacity for each inverter model.

Inverter model	Cable cross section 0-5m	Cable cross section 5-10m	Fuse rating	Battery capacity
12/1600	1 x 70mm ²	Not recommended	250A	300 - 800Ah
24/1600	1 x 35mm ²	1 x 70mm ²	125A	150 - 400Ah
48/1600	1 x 16mm ²	1 x 25mm ²	60A	75 - 200Ah
12/2000	1 x 70mm ²	Not recommended	300A	350 - 1000Ah
24/2000	1 x 50mm ²	1 x 95mm ²	150A	200 - 500Ah
48/2000	1 x 25mm ²	1 x 50mm ²	80A	100 - 250Ah
12/3000	1 x 90mm ²	2 x 70mm ² (*)	400A	400 - 1200Ah
24/3000	1 x 50mm ²	2 x 50mm ² (*)	250A	200 - 700Ah
48/3000	1 x 35mm ²	2 x 35mm ² (*)	125A	100 - 400Ah
24/5000	1 x 90mm ²	2 x 95mm ² (*)	400A	300 - 1500Ah
48/5000	1 x 70mm ²	2 x 70mm ² (*)	200A	150 - 700Ah

(*) One cable must be sized to carry the rated fuse current without overheating. Do not locate battery cables in a closed conduit. Please follow local installation rules.

Sufficient cable thickness and appropriate sized batteries are an important factor. Please consult your supplier or see the relevant sections of our books: [Energy Unlimited](#) and [Wiring Unlimited](#), both downloadable from our website.

Battery connection procedure



Use an insulated box spanner in order to avoid shorting the battery.
The maximum torque is 11Nm.
Avoid shorting the battery cables.

Proceed as follows to connect the battery cables:

- Be aware that reverse polarity connection (+ to – and – to +) will cause damage to the inverter.
- Connect the battery cables to the + (red) and the - (black) battery terminals.
- Secure the battery connections tightly, while not exceeding the maximum 11Nm torque. A tight connection will reduce the contact resistance as much as possible.

3.2.2. Solar connection

- Be aware that reverse polarity connection of the solar panel wires can cause damage to the inverter.
- Connect the solar panel cables to the positive (red) and the negative (black) PV terminals.
- Secure the PV connections tightly. A tight connection will reduce the contact resistance as much as possible.



Do not connect a battery or DC Power supply to the Solar connection. This will cause damage to the inverter.

3.2.3. Chassis to ground connection

Wire size for connecting the inverter chassis to ground:

The earth conductor from the earth lug on the chassis to ground should have at least half the cross-section of the conductors used for the battery connection.

The earth lug on the chassis is a M6 bolt.

The AC output is not isolated from the DC input. The AC output Neutral is connected to chassis/ground. If the installation requires a floating neutral, the neutral to ground link needs to be removed. See appendix [Installation information floating ground 1600VA](#)

and 2000VA models [20] or appendix [Installation information floating ground 3000VA and 5000VA models \[21\]](#) on how to do this.

3.2.4. Remote connector

Remote on/off control of the inverter can be achieved with a simple on/off switch connected to the inverter remote connector.

The inverter will switch on when it has been switched to ON or ECO mode and when:

- Contact is made between the remote connector H (left) terminal and L (right) terminal, for example via the wire bridge, a switch or the Inverter control panel.
- Contact is made between the remote connector H (left) terminal and battery positive.
- Contact is made between the remote connector L (right) terminal and battery negative.

Some usage examples of the remote connector are:

- If the inverter is situated in a vehicle and is only allowed to operate when the engine is running. Connect the remote connector H (right) terminal to the vehicle ignition switch.
- If the inverter is connected to a lithium battery the inverter can be controlled by the lithium battery BMS.



- For safety purposes, the inverter can be turned off completely by removing the remote connector. Do this by pulling the remote connector out of its socket. This ensures that the inverter cannot be turned on anymore via its switch, push button or Bluetooth. The user can now be certain that the inverter is definitely turned off and it cannot be accidentally turned back on by another user.

Inverter control panel

If a [Inverter Control VE.Direct](#) panel is used, it needs to be connected to the inverter remote connector as is indicated in below image. Note that the connection is polarity dependent for proper operation.

3.2.5. VE.Direct connection

The VE.Direct connection can be used for monitoring of the inverter via a GX device, or to connect to the VictronConnect app.

The following items can be connected:

- A GX device or GlobalLink 520 using a [VE.Direct cable](#).
- A GX device using a [VE.Direct to USB interface](#).
- A computer running the VictronConnect app using the [VE.Direct to USB interface](#).
- A phone or tablet running the VictronConnect app using the [VE.Direct Bluetooth Smart dongle](#).

3.2.6. Programmable relay

The programmable relay can be connected to an external circuit, for example an alarm circuit, a generator remote start circuit or a monitoring circuit.

Some usage examples are:

- Remote start a generator when the inverter has a low battery alarm.
- Drive an extraction fan when the inverter has a temperature alarm.
- Activate an alarm light or a buzzer when an inverter alarm occurs.

The programmable relay has 3 connections:

- Normally closed (NC).
- Common (COM).
- Normally open (NO).

Depending on its programming the relay will make contact between "common" and "normally closed" or between "common" and "normally open".

4. Configuration

The inverter is ready for use with the standard factory settings (see the [Technical specifications \[16\]](#) chapter).

The inverter can be configured using the [VictronConnect app](#). Connect using a smartphone or tablet via Bluetooth or using a computer via USB and a [VE.Direct to USB interface](#)).



- Settings may only be changed by a qualified engineer.
- Carefully read the instructions before changes are made.

4.1. AC output voltage and frequency

The inverter is set by default at 230Vac.

The AC output voltage and frequency can be set to a different value according to below table.

Model	AC output voltage range	Frequency range
230Vac models	Between 210Vac and 245Vac	50Hz or 60Hz

4.2. ECO mode and ECO settings

The inverter is equipped with ECO mode. ECO mode is activated via the VictronConnect app, the inverter main switch or push button (depending on inverter model).

When the inverter is in ECO mode, it will reduce its power consumption by approximately 85% when there are no loads connected to the inverter.

When the inverter is in ECO mode, the inverter will switch to search state when there is no load or a very low load. While in the search state, the inverter is off and will switch on every 3 seconds for a short period (adjustable). If the inverter detects a certain size load (adjustable) the inverter will go back to normal operation mode. Once the load drops below a certain level, the inverter will go back to ECO mode.

Below table indicates the default settings and setting range of the ECO parameters:

Parameter	Default value	Range
Wake-up power	60VA	0VA - inverter rating
Shutdown power	50VA	0VA - inverter rating
ECO mode search interval	3s	0 - 64s
ECO mode search time	0.16s	0.08 - 5.00s



- Note that the required ECO mode settings are heavily dependent on the type of load: inductive, capacitive, non-linear. Adjustment for specific loads may be needed.

4.3. Low battery alarm and charge detect settings

The inverter has two different types of low battery shutdown modes:

- Low battery shutdown based on battery voltage. This is the "low battery shutdown" voltage.
- Low battery shutdown based on battery voltage as a function of battery load. This mode is disabled by default. See next chapter [Dynamic cut off \[8\]](#) for more information.

Once the inverter has shut down due to a low battery (regardless of the mode):

- The inverter will restart again once the battery voltage has increased above the "low battery restart and alarm" level.
- The inverter will clear the low battery alarm once it detects the battery is being charged. This is the "charge detect" voltage.

Battery voltage	Low battery shutdown	Low battery restart & alarm	Charge detect
12V	Default: 9.3V Range: 0-100V	Default: 10.9V Range: 0-100V	Default: 14V Range: 0-100V

Battery voltage	Low battery shutdown	Low battery restart & alarm	Charge detect
24V	Default: 18.6V Range: 0-100V	Default: 21.8V Range: 0-100V	Default: 28.0V Range: 0-100V
48V	Default: 37.2V Range: 0-100V	Default: 36.6V Range: 0-100V	Default: 56.0V Range: 0-100V

4.3.1. Dynamic cut off

The "Dynamic cut off" feature makes the low battery shutdown protection a function of the battery current drawn from the battery in relation to the battery voltage.

When a high current is being drawn from the battery, a lower cut off voltage threshold is being used, for example 10V. And similarly, when the battery is only being discharged slowly, a high cut off voltage is used, for example 11.5V.

In this way, a voltage drop, caused by the internal resistance in the battery, is compensated so that the battery voltage becomes a much more reliable parameter to decide when to stop discharging the battery.

The "Dynamic cut off" feature is most useful for batteries with a high internal resistance, like OPzV and OPzS batteries. It is a bit less relevant for GEL and AGM batteries and perhaps even irrelevant for lithium batteries. The below graph shows the discharge ratio versus battery voltage curve for the different battery types. You can see that the lithium curve (LiFePO4) is nearly flat compared to the OPzV and OPzS curve.

The curve can be adjusted in the VictronConnect app.

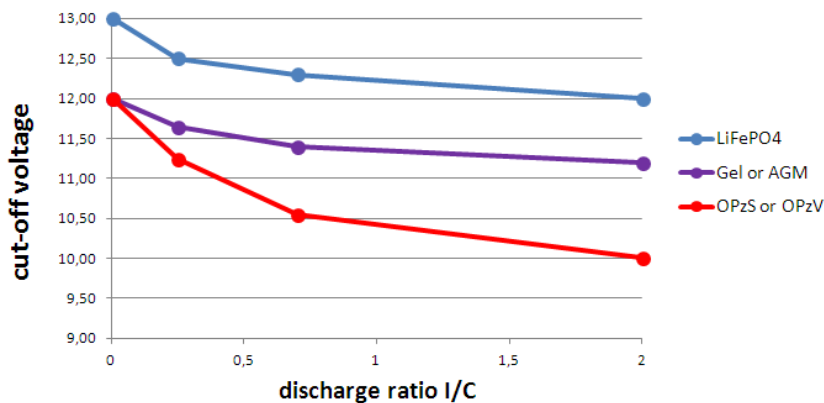

Discharge ratio versus battery voltage graph for different battery types



- Do not use the "Dynamic cut off" feature in an installation that also has other loads connected to the same battery. In these systems the battery voltage might drop because of other loads connected to the battery. The dynamic cut off algorithm in the inverter can not take those other loads into consideration and will shut down the Inverter too early with an under voltage alarm.

VictronConnect settings

- The "Dynamic cut off" feature is disabled by default.
- Enable the "Dynamic cut off" feature to use and configure it.
- Select the battery type. Choose between: OPzV/OPzS, GEL/AGM, LiFePO4 or Custom.
- Enter the battery capacity.
- Enter the voltage for the various discharge currents. These values have already been set to the generic voltages that belong to the specific battery type that was selected earlier. Change these settings only in case they need adjustment and you know what you are doing, or in case a custom battery is being used.

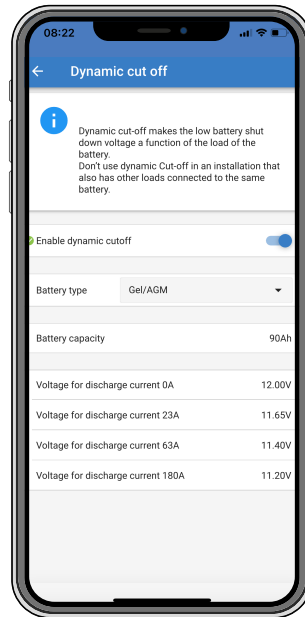

VictronConnect app showing the "Dynamic cut off" settings

4.4. Programmable relay

The inverters are equipped with a multi-functional relay that by default is programmed in the normal operation mode. The different relay modes can be summarized as follows:

Inverter (default setting)

Relay closed during normal operation, and opened when the inverter has switched itself off in alarm, has been switched off by a user and also opened (of course) when there is no power available on the terminals, ie. battery disconnected. In ECO mode, the relay will be closed both when searching for a load and when fully on, ie. load detected. Use this option when you want the relay to signal that there is power available on the output of the inverter.

Alarm

As above, but then the relay also opens when there is a warning. For example because the battery voltage dropped to the cut-off value, or when loaded to the point where it will almost shut down due to overload. In ECO mode, the relay will be closed both when searching (no load) and when fully on (load detected), except when there is a warning.

Use this option when you want the relay to signal that it is time to do something (charge the battery, reduce the load, and so forth), in order to prevent a power outage.

Low battery

Relay on during normal operation. The relay will switch off once there is a low battery warning. It will remain off in case the inverter shuts down due to low voltage, and will only switch back on again once the inverter is operational and the battery voltage is above the pre-alarm reset level. Use this option for load shedding, or to automatically start a generator. Note that this can only be considered a poor-mans generator start/stop. For more and better options, see the [generator start/stop paper](#).

Fan



Relay is off, unless the fan inside the inverter is running. Use this option to switch an external fan, for situations when the inverter is in a small enclosed space.

Off

This option sets the relay in the OPEN position. Use this option if you do not plan to use the relay function.



4.5. Firmware update

The firmware can be updated in the inverter product settings:

- Navigate to the inverter settings by clicking on the cog  symbol in the right top corner.
- Click on the 3 dot  symbol in the right top corner.
- Choose "Product settings" from the menu.
- The firmware section will display the firmware version and a button to perform a firmware update.

4.6. Reset settings to default

The inverter settings can be set to default in the following way:

- Navigate to the inverter settings by clicking on the cog  symbol in the right top corner.
- Click on the 3 dot  symbol in the right top corner.
- Select "Reset to defaults" from the menu and the settings will reset to default.

5. Operation

5.1. Inverter

The inverter can be turned on via these methods:

- Front push button.
- Main power switch at bottom of unit (5kVA model only).
- The VictronConnect app.
- Remote terminal with wire loop.
- Remote switch connected to the remote terminal (optional).
- Inverter Control VE.Direct panel connected to the remote terminal (optional).
- A GX device and the VRM portal (optional).

5.1.1. On/Off Push button

When switched to “ON” with the push button, the product is fully functional. The inverter will come into operation and the LED “inverter” will light up. By pushing the push button subsequently, within a short period of time, the inverter toggles between “ON”, “ECO” and “OFF”. The inverter goes into sleep mode with minimal current consumption when the unit is turned off by the push button.

Note that when the inverter is switched off via Bluetooth or the push button, it cannot be switched on and off again via the wired VE.Direct port.

5.1.2. On/off Switch (5kVA only)

In addition to the front push button, the 5kVA model also has a main on/off switch. This switch, when turned off, will cut off the supply current completely.

The switch is located at the bottom right of the inverter, next to the battery cable entries.

5.1.3. ECO Mode







The inverter can be switched to ECO mode, via the VictronConnect app or the front push button.

When the inverter is running in ECO mode it reduces power consumption in no-load (standby) operation. The inverter will automatically switch off as soon as it detects that there is no load connected. It then switches on, briefly, every 3 seconds to detect a load. If the output power exceeds the set level, the inverter will continue to operate.

For more information about ECO mode, see the [ECO mode and ECO settings \[7\]](#) chapter.

5.2. LED definitions and troubleshooting

LED panel	LED behaviour	Operational mode	Troubleshooting
	All LEDs are off.	The inverter has been switched off, either directly or via its remote on/off connector, or the inverter is not powered.	<p>To check if inverter is operational, push the "mode" button once.</p> <p>If not operational, check the following:</p> <ul style="list-style-type: none"> • Check the remote on/off connector. Is the wire loop in place or is the remote switch or remote panel switched on? • Check the DC cable connections and external fuses. Do you measure battery voltage at the inverter battery connection?

LED panel	LED behaviour	Operational mode	Troubleshooting
	The green inverter LED is on.	The inverter has been switched on and is operational.	n/a
	The green inverter LED is blinking. The yellow ECO LED is on.	The inverter has been switched to ECO mode and is in "search" state. In other words, the inverter load is lower than the "Wake up power" setting. the inverter sends a search pulse at regular intervals to check if a load has been connected or has been turned on.	If the inverter keeps switching on and off while there is a load connected, the load may be too small compared to the actual ECO mode settings. Either increase the load or change the "wake up power" setting.
	The green inverter LED is on. The yellow ECO LED is on.	The inverter has been switched to ECO mode and is in "inverting" state. In other words, the inverter load is higher than the "Shut down power" setting and is powering the load.	n/a
	The green inverter LED is blinking. The red Alarm LED is blinking.	The inverter is off and a firmware update is in progress or a firmware update has failed.	If the firmware update failed, retry the firmware update.
	The green inverter LED is on. The red Alarm LED is on.	Overload warning. The inverter is indicating that the AC load is larger than the inverter rating and that if this situation continues, the inverter will switch off due to an overload alarm	Reduce the AC load
	The green inverter LED is blinking with a fast double pulse. The red Alarm LED is on.	Overload alarm. The inverter has shut down due to prolonged overload and will no longer automatically restart.	Remove the cause of the overload and then restart the inverter by switching it off and then back on again.
	The green inverter LED is on. The red Alarm LED is slowly blinking.	Low battery voltage warning. The battery voltage has dropped below the "Low battery alarm" voltage. Should the battery voltage drop any further, the inverter will switch off on a "Low battery voltage alarm".	Charge the battery and/or turn AC loads off. Also check if all battery cable connections have been tightened. Do the battery cables have a sufficient thickness, is the battery full and is the battery still in good working order?
	The green Inverter LED is on. The red Alarm LED is fast blinking.	High Battery voltage warning. The battery voltage is too high. Should the battery voltage increase any further, the inverter will switch off on a "High battery voltage alarm".	Reduce the DC input voltage, check if the battery voltage is correct and if the battery bank is wired correctly. Also check if there perhaps are faulty or incorrect chargers or equipment with a faulty charge regulator.

LED panel	LED behaviour	Operational mode	Troubleshooting
	<p>The green Inverter LED is on.</p> <p>The red Alarm LED is blinking with a double pulse.</p>	<p>High temperature warning.</p> <p>The internal temperature is too high. If the temperature increases any further, the inverter will switch off on a "High temperature alarm".</p>	<p>Reduce the AC load and/or move the inverter to a better ventilated area.</p>
	<p>The green Inverter LED is on.</p> <p>The Alarm LED is blinking with a fast single pulse.</p>	<p>High DC ripple warning.</p> <p>The DC voltage has a too high ripple voltage. If the ripple voltage increases any further, the inverter will switch off on a "High DC ripple alarm".</p>	<p>Check if all battery cable connections have been tightened. Do the battery cables have a sufficient thickness? DC ripple is related to a voltage drop over the battery cables. For more information on DC ripple and how to prevent it, see the Wiring Unlimited book.</p>
	<p>The green inverter LED is blinking with a fast double pulse.</p> <p>The red Alarm LED is slowly blinking.</p>	<p>Low battery voltage alarm.</p> <p>The inverter has shut down due to low battery voltage.</p>	<p>To restart the inverter, charge the battery or switch the inverter off and then back on again.</p> <p>Check the battery voltage at the battery terminals of the inverter. Also check the DC fuses, cables, and cable connections</p> <p>For more information also see the Protections and automatic restarts [14] chapter.</p>
	<p>The green inverter LED is blinking with a fast double pulse.</p> <p>The red Alarm LED is fast blinking.</p>	<p>High battery voltage alarm.</p> <p>The inverter has shut down due to high battery voltage.</p>	<p>Reduce the DC input voltage, check if the battery voltage is correct and if the battery bank is wired correctly. Also check if there perhaps are faulty or incorrect chargers or equipment with a faulty charge regulator.</p> <p>The inverter will automatically turn back on when the battery voltage has dropped to an acceptable level.</p> <p>For more information also see the Protections and automatic restarts [14] chapter.</p>
	<p>The green inverter LED is blinking with a fast double pulse.</p> <p>The red Alarm LED is blinking with a double pulse.</p>	<p>High temperature alarm.</p> <p>The inverter has shut down due to high temperature.</p>	<p>Wait until the inverter has cooled down.</p> <p>The inverter will automatically turn back on when its internal temperature has dropped to an acceptable level.</p> <p>Check the environment of the inverter, can the ventilation be improved, or can the inverter be moved to a cooler location?</p> <p>For more information also see the Protections and automatic restarts [14] chapter.</p>
	<p>The green inverter LED is blinking with a fast double pulse.</p> <p>The Alarm LED is blinking with a fast single pulse.</p>	<p>DC ripple alarm.</p> <p>The inverter has shut down due to high DC ripple.</p>	<p>Check if all battery cable connections have been tightened. Do the battery cables have a sufficient thickness? DC ripple is related to a voltage drop over the battery cables. For more information on DC ripple and how to prevent it, see the Wiring Unlimited book.</p> <p>To restart the inverter switch the inverter off and then back on again.</p> <p>For more information also see the Protections and automatic restarts [14] chapter.</p>

5.3. Protections and automatic restarts

Overload

Some loads like motors or pumps draw large inrush currents in a start-up situation. In such circumstances, it is possible that the start-up current exceeds the over current trip level of the inverter. In this case the AC output voltage will quickly decrease to limit the output current of the inverter. If the over current trip level is continuously exceeded, the inverter will shut down, wait 30 seconds and then restart.

After 3 restarts, followed by another overload within 30 seconds of restarting, the inverter will shutdown and remain off. The LEDs will signal shutdown due to overload. To restart the inverter, switch it off and then back on again.

Low battery voltage (adjustable)

The inverter will shut down when the DC input voltage drops below the "Low battery shutdown" parameter. The LEDs will signal shutdown due to low battery. The inverter will automatically restart, after a minimum delay of 30 seconds, when the battery voltage has increased above the "Low battery restart" parameter.

After three restarts, followed by another low battery shutdown within 30 seconds of restarting, the inverter will shutdown and remain off. The LEDs will signal shutdown due to low battery. To restart the inverter, switch it off, and then on again. Alternatively, recharge the battery. The inverter will automatically restart when the battery voltage has increased for at least 30 seconds above the "Charge detect" parameter.

See the [Technical specifications \[16\]](#) chapter for default low battery shutdown and restart levels. The levels can be customized via the VictronConnect app.

Alternatively, a dynamic low battery cut off can be implemented. For more information, see the [Dynamic cut off \[8\]](#) chapter.

High battery voltage

The inverter will shut down when the DC input voltage is too high. The LEDs will signal shutdown due to high battery. The inverter will first wait 30 seconds and will only resume operation once the battery voltage has dropped to an acceptable level.

Check for faulty battery chargers, alternators or solar chargers connected to the battery.

High temperature

The inverter will shut down if it detects a too high internal temperature. The LEDs will signal shutdown due to high temperature. The inverter will wait 30 seconds and will only resume operation when the temperature has dropped to an acceptable level.

High temperature alarms are generally caused by a too high ambient temperature, often in combination with a high inverter load. Check if the area the inverter is used in, is well ventilated and perhaps even air-conditioned.

High DC ripple

The inverter will shut down if it detects a too high DC ripple. The LEDs will signal shutdown due to high DC ripple. The inverter will wait 30 seconds and then resumes operation again. If after 3 restarts, the DC ripple voltage is still too high, the inverter will shutdown and will not attempt to restart again. To restart the inverter, switch it off and then switch it on again.

High DC ripple is usually caused by loose DC cable connections and/or too thin DC wiring. To clear or prevent ripple alarms, check the wiring between the battery and the inverter. Check if the wiring is the recommended thickness, that all connections are tightened correctly and that the fuses and battery isolators are in good working order. For more information on DC ripple see the [Wiring Unlimited book](#).

Continuous high DC ripple reduces the life expectancy of the inverter.

5.4. Monitoring via VictronConnect

The VictronConnect app can be used to monitor the inverter.



VictronConnect app.

For information on how to connect see the [The VictronConnect app \[2\]](#) chapter and/or the VictronConnect manual which can be found on the [VictronConnect app information page](#).

The VictronConnect app will display the following information:

- Inverter load in VA.
- AC output voltage.
- Battery voltage.
- Operational state.
- Programmable relay state.
- Warning or alarm messages *.
- Solar current **.

*) Please note that the app is not active in the background. This means that the app will not send alarms or warnings to your phone unless the app is active in the foreground.

5.5. Monitoring via a GX device, GlobalLink and the VRM portal

The inverter can be connected to a GX device, like a [Cerbo GX](#) or a [Color Control GX](#). When connected the GX device will display the inverter on the system overview screen and the device list. The GX device will also display a message in case of an inverter warning or alarm.

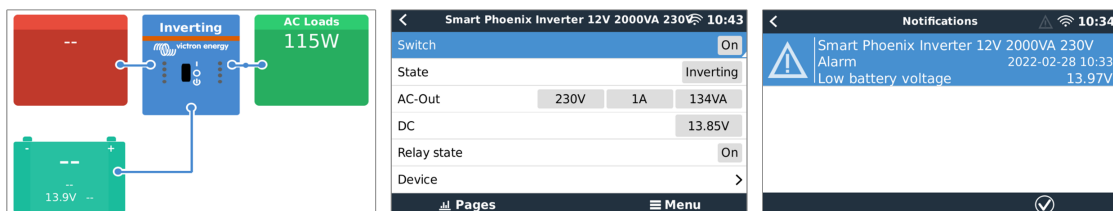

Example of GX screens from left to right: system screen, inverter device screen and an alarm message.

If the GX device is connected to the internet, the inverter can be remotely monitored via the VRM portal. For more information on the VRM portal, see the [VRM - Remote monitoring](#) information page.

Alternatively, the inverter can be connected to a [GlobalLink 520](#), and then remotely monitored via the VRM portal.

6. Technical specifications

6.1. Inverter Smart

Inverter Smart	12/1600	12/2000	12/3000	
	24/1600	24/2000	24/3000	24/5000
	48/1600	48/2000	48/3000	48/5000
Parallel and 3-phase operation	No			
INVERTER				
Input voltage range	9.3 - 17V, 8.6 - 34V or 37.2 - 68V			
AC Output	230Vac ±2%, 50Hz or 60Hz ± 0,1% (Non-linear load, crest factor 3:1)			
Continuous output power at 25°C ⁽¹⁾	1600VA	2000VA	3000VA	5000VA
Continuous output power at 25°C	1300W	1600W	2400W	4000W
Continuous output power at 40°C	1200W	1450W	2200W	3700W
Continuous output power at 65°C	800W	1000W	1700W	2800W
Peak power	3000VA	4000VA	6000VA	10000W
Short-circuit output current	13.9A	17.4A	26.0A	43.5A
Dynamic DC low shut down	Load dependant, configurable, see Dynamic cut off [8] chapter			
Maximum efficiency (12/ 24 /48V)	92 / 94 / 94%	92 / 94 / 94%	93 / 94 / 95%	95 / 96%
Zero load power 12 / 24 / 48 V	8 / 9 /11W	8 / 9 / 11W	12 / 13 / 15W	18 / 20W
Zero load power in ECO mode	0.6 / 1.3 / 2.1W	0.6 / 1.3 / 2.1W	1.5 / 1.9 / 2.8W	2.2 / 3.2W
GENERAL				
Programmable relay	DC rating 4A@35V or 1A@60V, AC rating: 3A@230V			
Stop & start power ECO-mode	Adjustable via VictronConnect app			
Protection	Output short circuit, overload, low battery voltage, high battery voltage, over temperature, AC voltage on AC output, high DC ripple.			
Bluetooth wireless communication	For remote monitoring and system integration			
VE.Direct communication port	For remote monitoring and system integration			
Remote on/off connector	Yes			
Operating temperature range	-40 to +65°C (fan assisted cooling)			
Humidity (non-condensing)	max 95%.			
Maximum altitude	2000m			
Pollution degree classification	PDII			
Over voltage category	Mains: OVII			
ENCLOSURE				
Material and colour	Steel (blue RAL 5012; and black RAL 9017)			
Protection category:	IP21			
Battery connection terminals	M8 bolts	M8 bolts	12 V/24 V: 2+2 M8 bolts 48 V: M8 bolts	24 V: 2+2 M8 bolts 48 V: M8 bolts
AC output connection terminals	Screw terminals			
Weight	12kg	13kg	19kg	29kg / 28kg

Inverter Smart	12/1600	12/2000	12/3000	
	24/1600	24/2000	24/3000	24/5000
	48/1600	48/2000	48/3000	48/5000
Dimensions (hxwhd)	485 x 219 x 125mm	485 x 219 x 125mm	533 x 285 x 150mm (12V) 485 x 285 x 150mm (24/28V)	595 x 295 x 160mm (24V) 555 x 295 x 160mm (48V)
STANDARDS				
Safety	EN-IEC 60335-1			
Emission Immunity	EN 55014-1 / EN 55014-2 / EN-IEC 61000-6-1 / EN-IEC 61000-6-2 / EN-IEC 61000-6-3			
Automotive Directive	ECE R10-5			

7. Appendix

7.1. Connection overview



Connections 1600VA model

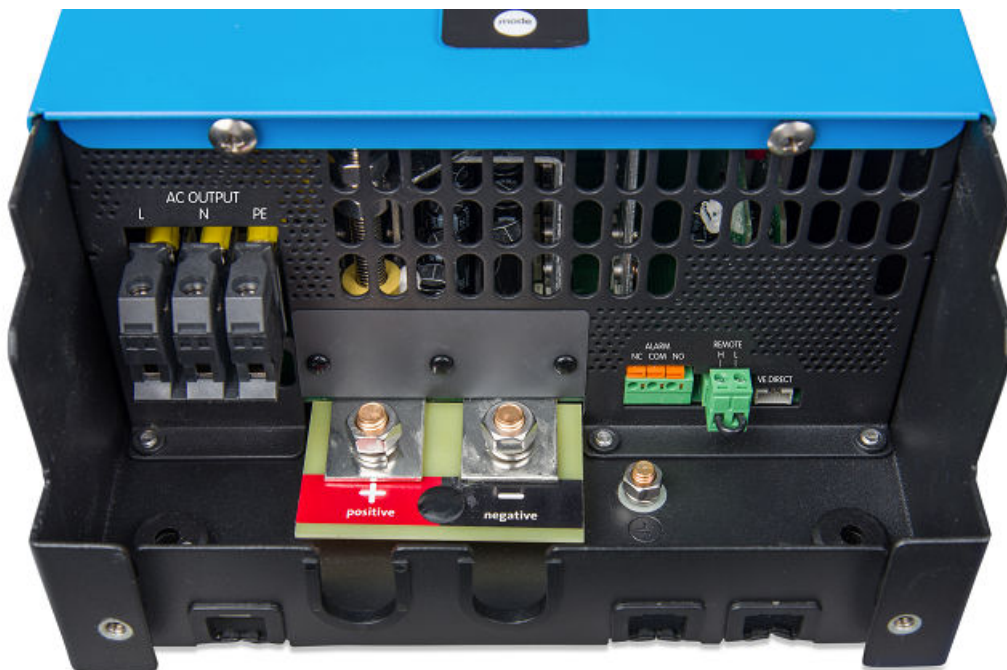

Connections 2000VA model



Connections 3000VA model



Connections 5000VA model

#	Connector	Terminal names
A	AC output	L (phase), N (neutral), PE (earth)
B	Battery	+ (positive), - (negative)
C	Alarm (programmable relay)	NO, COM, NC
D	Remote	H, L
E	VE.Direct	VE.Direct

7.2. Installation information floating ground 1600VA and 2000VA models

Ground wire "G" connects the output neutral to ground. It must be re-positioned to a "dummy" terminal if a floating output is required.

When a floating output is obtained, the current reading at no load can show an offset of around 100 - 50mA. Also beware that a GFCI (or RCCB) will not function properly.

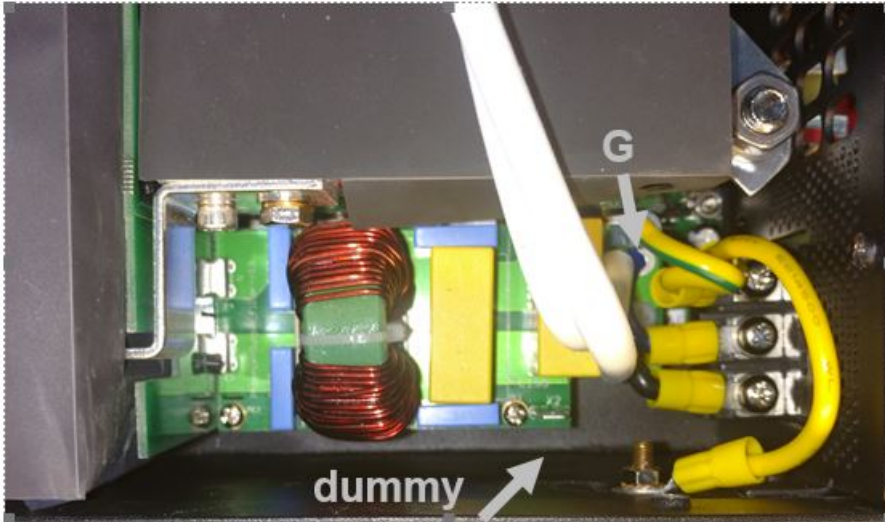

7.3. Installation information floating ground 3000VA and 5000VA models

Ground wire "G" connects the output neutral to ground. It must be re-positioned to a 'dummy' terminal if a floating output is required.

When a floating output is obtained, the current reading at no load can show an offset of around 100 - 150mA. Also beware that a GFCI (or RCCB) will not function properly.

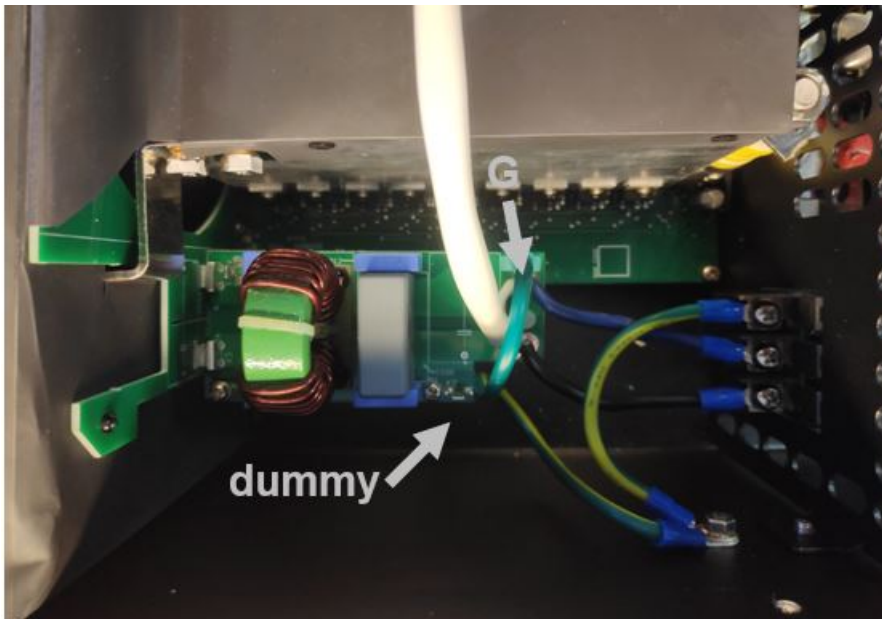

7.4. Dimensions 1600VA and 2000VA model

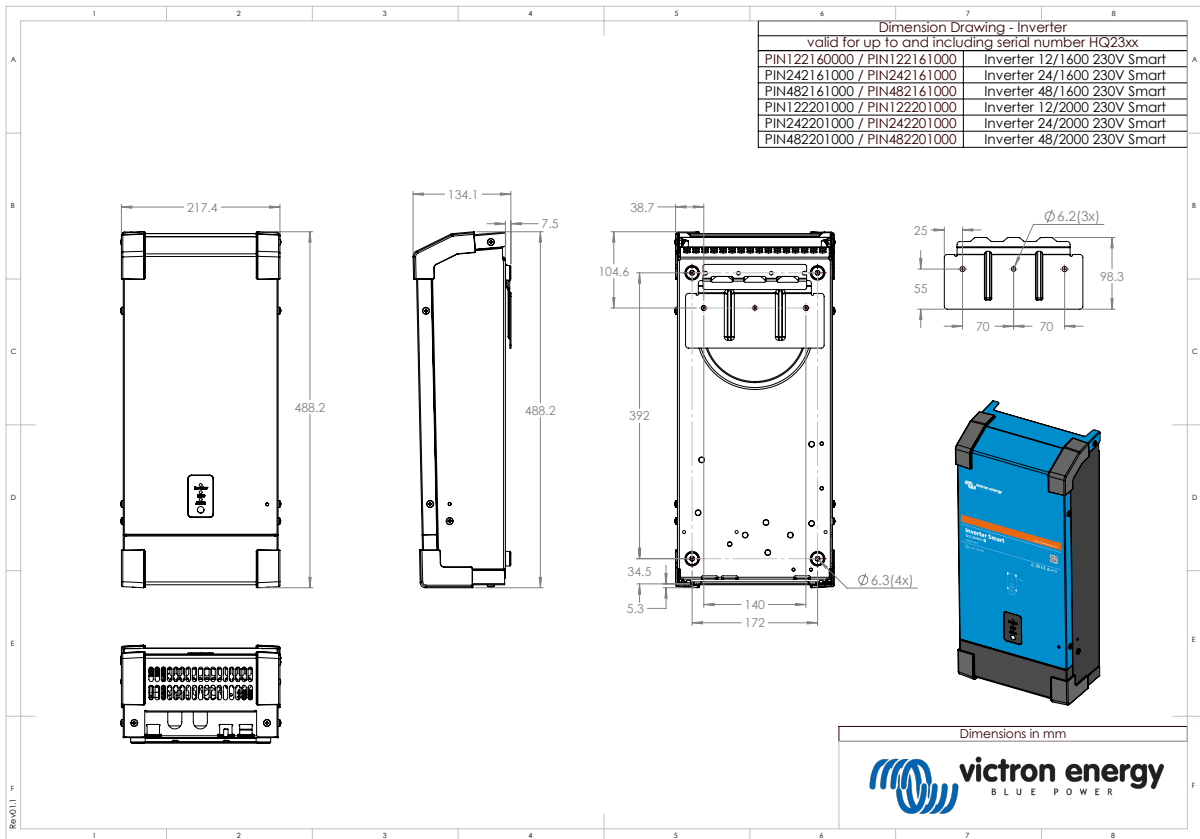
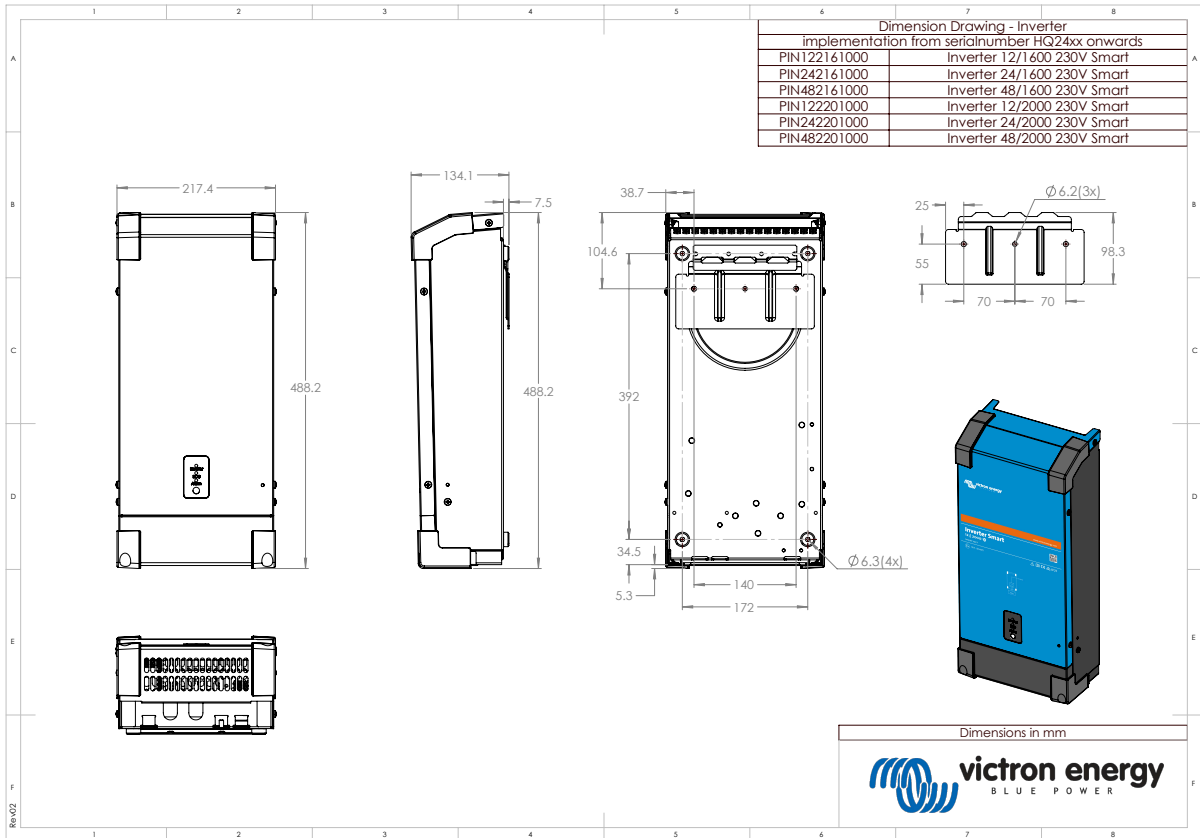

7.5. Dimensions 3000VA model (12V)

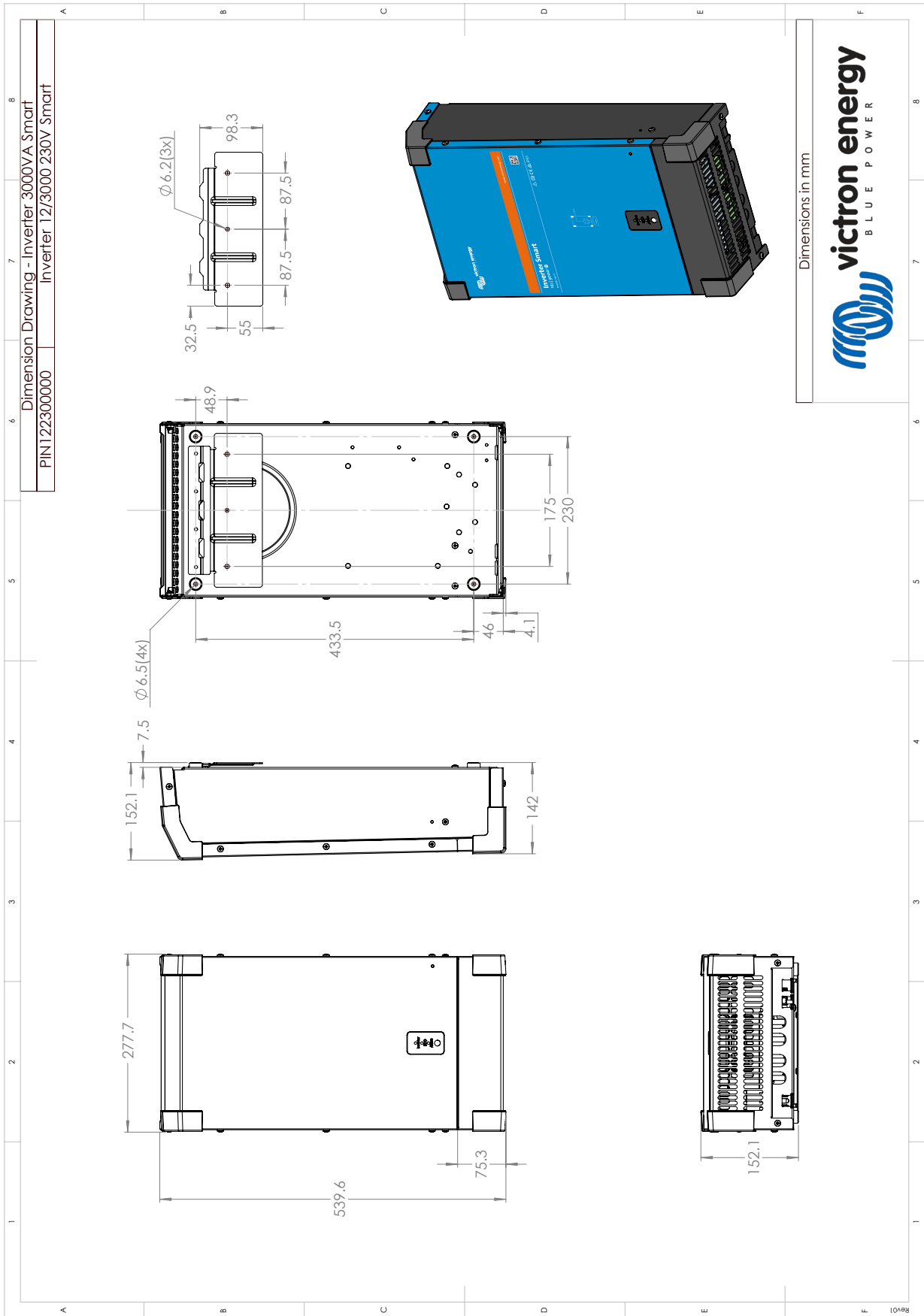

7.6. Dimensions 3000VA model (24V, 48V)

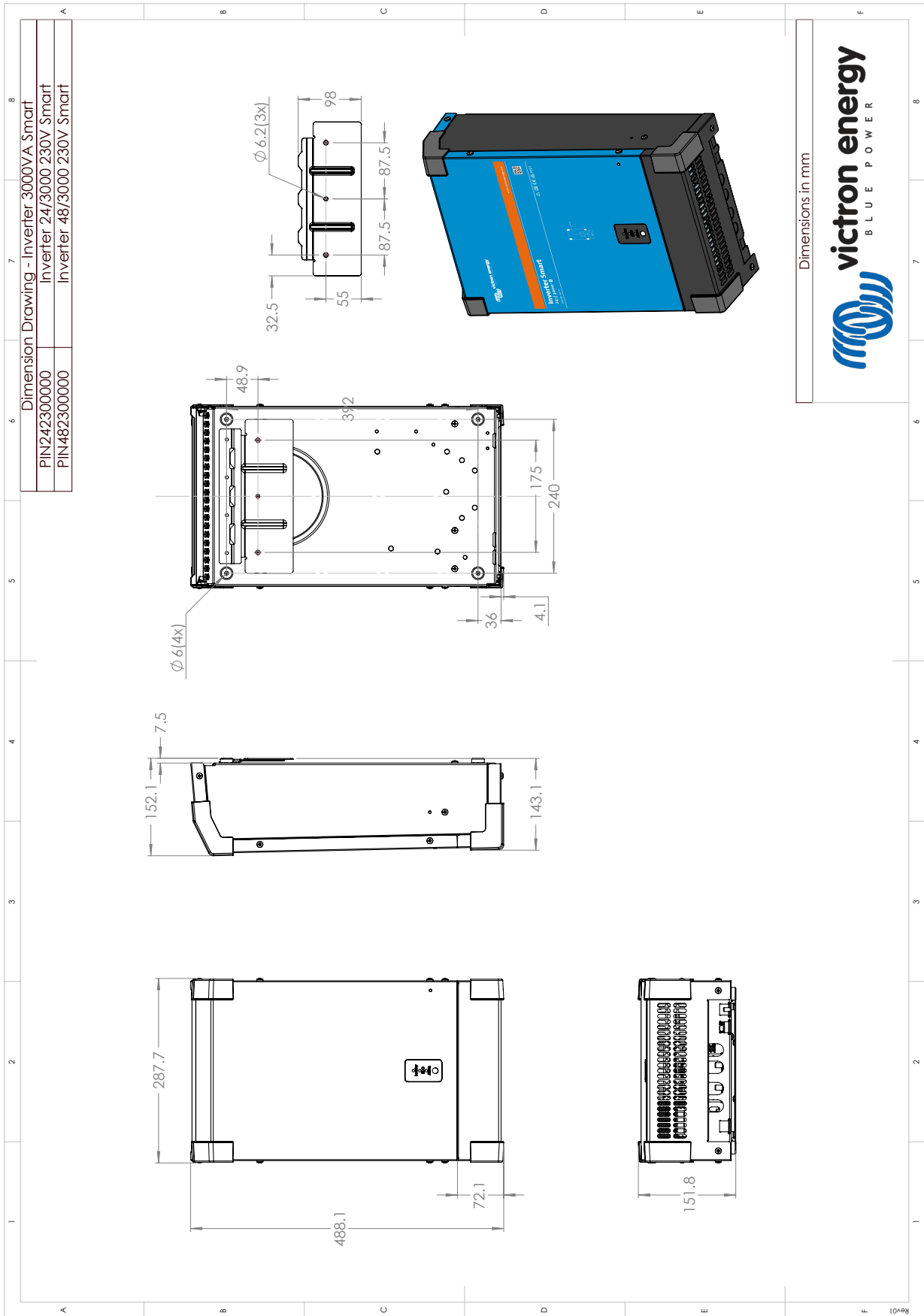

7.7. Dimensions 5000VA model

